



TECHNONICOL



Manual

for installation of polymer-bitumen membrane for foundation waterproofing

KNOWLEDGE. EXPERIENCE. CRAFTSMANSHIP.



We are proud of what we produce and create. We enjoy seeing how new high-quality materials are produced from plain raw components with our up-to-date equipment, our work and efforts. We are continuously improving ourselves and strive to do the same for the environment. We prefer to address the comprehensive energy efficiency of buildings and structures. Our innovative solutions enable us to create high technology and energy-efficient buildings, improve the quality of buildings under construction, cut down operation and construction costs. We are glad to know that our materials are used in the construction of houses, plants, bridges, social infrastructure facilities and other objects, which improve the level and quality of life of people.

Contents

1.	Introduction	3
1.1.	General information	5
1.2.	Materials applied.....	8
1.3.	Equipment used	12
2.	Surface preparation.....	13
2.1.	General information	15
2.2.	Surface preparation quality requirements.....	15
2.3.	Installation of transitional fillets and coves.....	16
3.	Surface priming.....	19
3.1.	General information	21
3.2.	Primer application.....	21
4.	Torch-on application of the waterproofing membrane.....	23
4.1.	General information	25
4.2.	Installation of materials on horizontal surfaces	26
4.3.	Installation of reinforcement layers.....	31
4.4.	Installation of materials on vertical surfaces	36
5.	Execution of units and elements	45
5.1.	General information	47
5.2.	Waterproofing membrane installation at the basement level.....	47
5.3.	Waterproofing of penetration piping	49
5.4.	External corner waterproofing.....	51
5.5.	Internal corner waterproofing	72
5.6.	Expansion joint sealing.....	93
6.	Protection of the waterproofing membrane	99
6.1.	Protection with PLANTER standard profiled HDPE membrane.....	101
6.2.	Protection with PLANTER geo profiled HDPE membrane used for wall drainage.....	104
6.3.	Protection with XPS TECHNONICOL CARBON.....	110
6.4.	Backfill of the foundation pit	112
7.	Quality control.....	113
8.	Safety precautions.....	117

1.

Introduction

1. Introduction

1.1. General information

This instruction has been developed for performing and checking the correctness of torch-on installation of the waterproofing roll-fed polymer-bitumen membrane with uniform adhesion to the base. The instruction covers the operations executable with following polymer-bitumen materials: ULTRAPLAST, ULTRAFLEX, ULTRAPLAST BRIDGE (Technoelast Most S), ULTRAFLEX BRIDGE (Technoelast Most B) and ULTRAFLEX GREEN.

NOTE: The waterproofing membrane not only protects the internal premises from water penetrating inside, reducing their operating ability, disturbing the process equipment operation and worsening the microclimatic conditions indoors, but it also prevents destruction of the facility foundation. Therefore, the correct selection and installation of the waterproofing membrane also ensures durability of the whole facility.

Polymer-bitumen membranes of TECHNOMICOL Corporation are applied for waterproofing of building structures and recommended for use in system solutions developed by the company's experts.

1.1.1. Waterproofing system for foundation without drainage and thermal insulation

The system is applied to protect underground structures with a technical floor or unexploited premises in sandy grounds with a low level of ground waters (below the bedplate level).



System composition:

- Ready to use solvent based BITUMEN PRIME COATING;
- TECHNOMICOL waterproofing polymer-bitumen membrane;
- PLANTER standard – profiled HDPE membrane used for protection of the waterproofing membrane.

1.1.2. Waterproofing system for foundation with drainage

The system is applied to protect underground structures with a technical floor or unexploited premises in clayey and loamy soils irrespective of the ground water level, as well as in sandy grounds with the ground water level above the bedplate level.



System composition:

- Ready to use solvent based BITUMEN PRIME COATING;
- TECHNONICOL waterproofing polymer-bitumen membrane;
- PLANTER geo – profiled HDPE membrane used for wall drainage (applied together with annular drains).

1.1.3. Waterproofing system for foundation with drainage and thermal insulation

The system is applied to protect underground structures with operated or living premises in clayey and loamy soils irrespective of the ground water level, as well as in sandy grounds with the ground water level above the bedplate level.



System composition:

- Ready to use solvent based BITUMEN PRIME COATING;
- TECHNONICOL waterproofing polymer-bitumen membrane;
- TECHNONICOL CARBON PROF 300 – XPS boards used for thermal insulation;
- PLANTER geo – profiled HDPE membrane used for wall drainage (applied together with annular drains).

1.1.4. Waterproofing system for foundation with thermal insulation

The system is applied to protect underground structures with operated or living premises in sandy grounds with a low level of ground waters (below the bedplate level).



System composition:

- Ready to use solvent based BITUMEN PRIME COATING;
- TECHNONICOL waterproofing polymer-bitumen membrane;
- TECHNONICOL CARBON PROF 300 – XPS boards used for thermal insulation.

1.1.5. Waterproofing system for diaphragm wall foundation

The system is applied to protect underground structures constructed in foundation pits with diaphragm walls.



System composition:

- Ready to use solvent based BITUMEN PRIME COATING;
- TECHNONICOL waterproofing polymer-bitumen membrane;
- TECHNONICOL CARBON PROF 300 – XPS boards used for thermal insulation;
- Needle-punched geotextile;
- PE film.

NOTE: Before starting the operations, please read carefully the present instruction, as well as design recommendations, design drawings and technical datasheets for applied materials.

1.2. Materials applied



- **ULTRAPLAST**
APP-modified bitumen membrane designed for creation of the multilayer waterproofing system.



- **ULTRAFLEX**
SBS-modified bitumen membrane designed for creation of the multilayer waterproofing system.



- **ULTRAPLAST BRIDGE (Technoelast Most S)**
APP-modified bitumen membrane designed for creation of the single-layer waterproofing system.



- **ULTRAFLEX BRIDGE (Technoelast Most B)**
SBS-modified bitumen membrane designed for creation of the single-layer and multilayer waterproofing system.



- **ULTRAFLEX GREEN**
SBS-modified bitumen membrane designed for creation of the external (facing the ground) layer in the multilayer waterproofing system, when the waterproofing membrane and building structures need protection from undesirable effects of root system of various plants.



- **Solvent based BITUMEN PRIME COATING**
intended for preparation (prime coating) of the surface before installation of torch-on waterproofing membrane.



- **NICOBAND DUO double-sided self-adhesive sealant tape:**
 - **150 mm** wide for fixing PLANTER geo wall drainage to concrete structures;
 - **75 mm** wide for sealing joints of PLANTER geo wall drainage rolls and overlap splicing of geotextile of the wall drainage.



- **NICOBAND self-adhesive sealant tape**
150 mm wide for sealing joints of PLANTER standard profiled HDPE membrane.



- **Edge strip with a fold flange**
used for mechanical fixing of the waterproofing membrane at the basement level.



- **Polyurethane sealant**
used for additional sealing of separate units (e.g., metal clamping gaskets in penetration piping).



- **TECHNICAL CARBON PROF 300**
XPS slabs used for installation of thermal insulation of the foundation and for protection of the waterproofing membrane from mechanical damage.



- **PLANTER standard**
profiled HDPE membrane used for protection of the waterproofing membrane from mechanical damage.

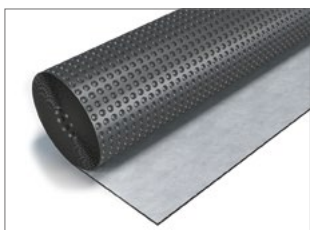

- **PLANTER geo**
profiled HDPE membrane used for installation of wall drainage.



- **Fixture**
for boards of XPS and for intermediate fixing of the profiled membrane.



- **Bitumen adhesive mastic TECHNICAL No.27**
for fixing slabs of XPS.

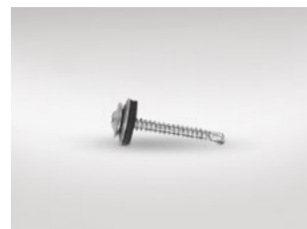

- **Self-tapping screw with clamping washer or concrete nail**
for fixing the profiled membrane at the basement level.



- **Edge profile**
for protection of the profiled membrane cavities from various waste.

1.3. Equipment used



Recommended list of equipment for a team of three workers:

- Gas cylinder – **2 pcs**;
- Gas pressure reducer – **2 pcs**;
- Oxygen hose – **2 pcs**;
- Big gas torch – **1 pc.**;
- Small gas torch – **2 pcs**;
- Metal feed roller – **1 pc.**;
- Silicone feed roller – **2 pcs**;
- Roofing knife with replaceable blades – **3 pcs**;
- Measuring tape – **2 pcs**;
- Perforation gun with drilling mode and set of punches and drills – **1 pc.**;
- Screw gun – **1 pc.**;
- Metal sweepers – **3 pcs**;
- Paint roller – **2 pcs**;
- Paint brushes – **4 pcs**;
- Split-leather gloves – **6 pairs**;
- Construction helmet – **3 pcs**.

2. Surface preparation

2. Surface preparation

2.1. General information

The surface preparation before applying the waterproofing membranes is one of the most important and often the most difficult and labor-consuming technological operation.

NOTE: Failure to meet the requirements to surface preparation will result in low quality of the waterproofing membrane and of the whole waterproofing system.

The concrete surface preparation methods are selected depending on the required surface evenness, extent of destruction of the structure, type and amount of damages, as well as the type of material intended for performing the operations for elimination of defects.

There are four main methods of concrete surface preparation:

Mechanical: with the use of perforators, jackhammers, wire-needle pneumatic hammers, picks, sandblasting and shot blasting machines, grinding machines and milling cutters, etc.;

Hydraulic: with the use of water jet systems with pressure from **180 to 1,200 atm.**;

Thermal: with the use of propane or acetylene-oxygen torches;

Chemical: with the use of hydrochloric or phosphoric acids.

2.2. Surface preparation quality requirements



- Absence of friable, easily peeling elements;
- Absence of cracks (especially parallel to expansion joints), spalls and blowholes, sections of non-vibrated concrete, etc.;
- Surface evenness – **5 mm** for **2 m** length in any direction;
- Concrete compressive strength – at least **1.5 MPa**;
- Removal of all pollution and materials hindering adhesion (dirt, dust, cement slurry, form oil, etc.);
- Mass humidity of the base concrete – no more than **4%**.

2.3. Installation of transitional fillets and coves

Before applying the polymer-bitumen roll materials, it is necessary to eliminate all sharp protuberances, corners, etc. to avoid the material crushing or static punching of the waterproofing membrane (e.g., when filling of a foundation pit with backfilled soil and in process of operation of a building), for which it is necessary to arrange transitional fillets or coves. Fillets are usually made of cement-sand grout of at least **M150** grade or polymer-cement slurry with fast strength setting. In any case, the size of fillets should be around **100 × 100 mm**.



- Clean the place to arrange the fillet (cove) from cement slurry, dust and dirt.



- Carefully spill the surface with water until full saturation.



- Prepare the mix for installation of fillet (cove), by using mechanical stirring means. It is forbidden to prepare the mix manually.



- Apply the prepared mix onto the surface, by forming a fillet (**100 × 100 mm** size) or a cove (**R=100 mm**).



- Ensure moisturizing of the laid material (pouring with water, wet bagging, etc.) during the necessary time (indicated by the producer of specific material and usually making **2-3 days** under the temperature of **+20°C**).
- Allow the laid material to stand during the time necessary for setting the demanded strength and moisture content.

3.

Surface priming

3. Surface priming

3.1. General information

When torching the polymer-bitumen roll-fed materials, it is necessary to ensure sufficient adhesion of materials to the base (**0.3÷0.5 MPa**). For this purpose, the concrete base should be primed with ready to use **BITUMEN PRIME COATING**. The primer consumption makes approximately **0.25÷0.35 l/m²** depending on the base coarseness and absorption capacity.

Alternative primers: **BITUMEN-POLYMER PRIME COATING**;
UNIVERSAL WATER BASED PRIMER.

NOTE: Bitumen primers **BITUMEN PRIME COATING** and **BITUMEN-POLYMER PRIME COATING** are applied to the base with mass humidity no more than 4%, while **UNIVERSAL WATER BASED PRIMER** can be applied to the bases with mass humidity up to 8% because it is a water emulsion of bitumen. Usually, mass humidity of concrete is determined by means of moisture meters.

3.2. Primer application



- Before applying the primer, clean the concrete surface from dirt and dust. In case of using a compressor for this purpose, it is necessary to ensure that it is equipped with a moisture and oil separator.



- Carefully mix the primer by a low-speed drill with the special nozzle.



- Apply the primer manually onto the cleaned surface with brushes, sweepers or paint rollers.



- Corners and other hard-to-reach spots must be daubed with a hard-bristle brush.

NOTE: It is not recommended to apply the primer mechanically (by air or airless sprayers), even with great volumes of works.



- Allow the treated surface to stand until the full drying of the primer. The primer drying time depends on its type and environmental conditions during the work.

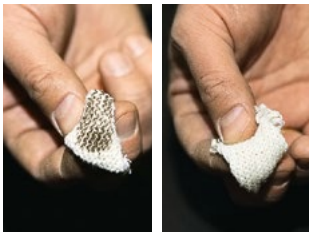

- It is possible to check whether the primer has dried by pressing a dabber to it: there should be no bitumen traces on the dabber pressed to the dried primer.

NOTE: When performing operations for applying the priming mix, it is not permitted to perform simultaneously the operations for torching of the waterproofing membrane and other operations with use of open flame (e.g., gas or electric welding).

4.

Torch-on application of the waterproofing membrane

4. Torch-on application of the waterproofing membrane

4.1. General information

The most widespread materials for creation of the waterproofing membrane are the polymer-bitumen roll-fed materials. This is due to a relative simplicity of installation, popularity of the technology and stability of the factory-set technical parameters of the materials. The roll-fed waterproofing can be single-layer and multilayer. The waterproofing membrane thickness depends both on the type of material applied and on the foundation depth. The total thickness of the waterproofing membrane can be also influenced by other factors, e.g., the chemical aggression of ground water.

NOTE: Torching of roll-fed polymer-bitumen materials onto horizontal surfaces is carried out on the concrete blinding. It is necessary to consider that the plan dimension of the concrete blinding should exceed the size of the bedplate at least by 300 mm (see the figure below). This is necessary for correct joining of the horizontal and vertical waterproofing membranes.

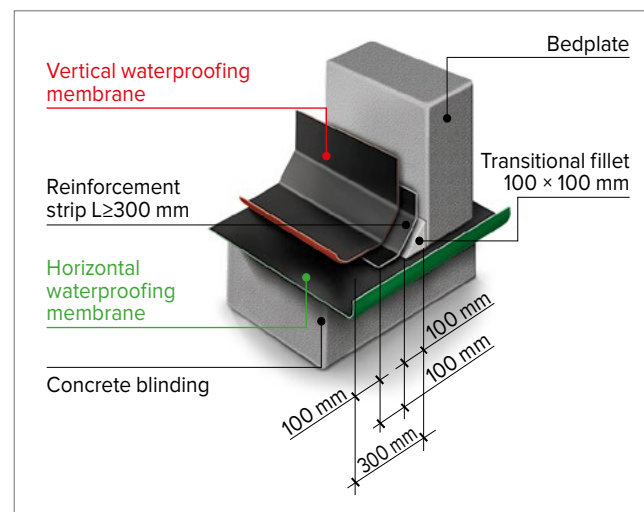

4.2. Installation of materials on horizontal surfaces

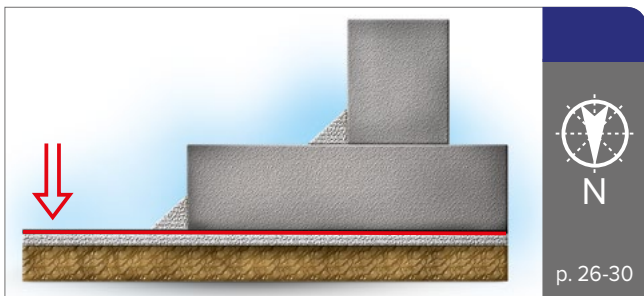

- Before torching the waterproofing membrane onto horizontal surfaces, unwind the whole roll on the prepared base, check and align it with the already laid roll, by ensuring the demanded width of overlapping on the longitudinal and transversal edges (see below). It is recommended to allow the material to stay in the unwound condition for some time to decrease the possibility of formation of defects in the laid membrane.

NOTE: One of the main conditions for absence of primary strains in the roll-fed polymer-bitumen materials is their correct transportation and storage. It is necessary to store the rolls in vertical position, by protecting them from moisture and direct sunlight (if there is no protective film on the pallet).

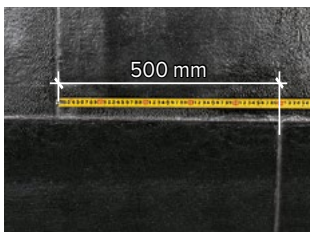

- Right before the torching, check the spacing between edge joints, which should be at least **500 mm**.



- The overlap at sheet ends (transversal) should be not less than **150 mm**.



- The overlap along edges joint (longitudinal) should be not less than **100 mm**. Recommended overlap for single-layer application of bitumen membrane is not less than **120 mm**.

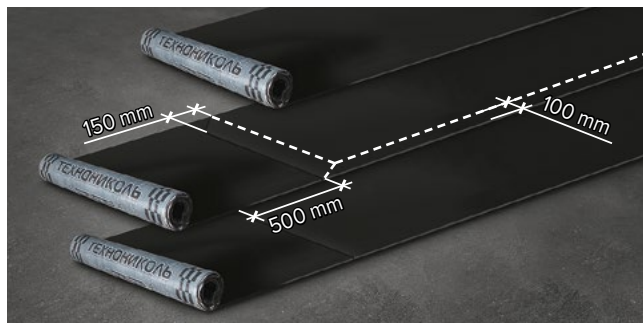

- In places of T-joints forming, cut the roll corner between the upper and lower rolls. The corner cutting allows raising the quality of the weld by preventing unwelded spots.



- After that, wind the material into a roll from both sides towards the center (to the middle). It is better to perform winding on a metal pipe or cardboard core.



- Perform torching by heating the bottom surface of the roll with a torch flame and simultaneously warming up the base surface. Torching is performed by smooth motions of the torch with paying particular attention to overlapping areas and gradually unwinding the roll towards yourself.

NOTE: It is strongly unrecommended to unwind the roll away from you. In such case, you will move upon the warmed material, which can lead to its deformation and, as a consequence, to loss of integrity of the waterproofing membrane.



- Small flow of the bitumen mass in the place of contact of the roll with the base testifies to correct temperature conditions of torching. The PE film on the bottom surface of the material should be completely flashed off. The indication pattern will be deforming during this operation.

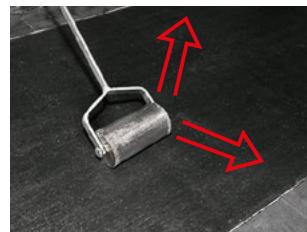

- The torched rolls should have no folds, wrinkles and waves. To avoid such defects, level their surfaces with a metal roller by diagonal motions from the roll axis to its edges, while the material is still softened. Take special care when leveling the overlapping areas.



- One of the signs of the weld seam tightness is the flowing out of bitumen mass from under the longitudinal edge of material as a compact bead, approximately for **5÷25 mm** (depending on material's thickness).

NOTE: When performing the installation in the conditions of temperatures below zero, it is necessary to warm the polymer-bitumen roll-fed materials up to the temperature above zero throughout the whole volume of material. For this purpose, it is necessary to allow the materials stand under the temperature no lower than +15°C within 24 hours.



- Install the second layer of the waterproofing membrane in a similar way. The distance between edges of the rolls in the first and second layers should be at least **300 mm**, but usually it is moved at a distance of **500 mm** (the roll middle).



- When torching the second layer, also control the overlapping: **100 mm** for edge overlapping and **150 mm** for end overlapping.

NOTE: When working with ULTRAFLEX GREEN membrane, it is necessary to consider that it is applied as external layer in a multilayer system. Accordingly, it is necessary to install it as the first layer onto a horizontal surface and the last layer onto a vertical surface.

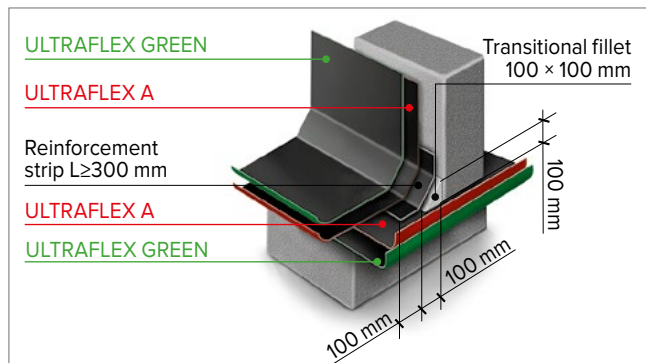

- Protect the waterproofing membrane from eventual mechanical damage (e.g., when mounting the reinforcing cage of a bedplate). A sand cement screed of at least **50 mm** thick is usually used as protection. Protect the place of future joint of the horizontal and vertical waterproofing membranes with panel board materials (e.g., plywood sheets), which allows to protect the membrane from mechanical damage and quickly dismantle such materials for further torching operations.

4.3. Installation of reinforcement layers

When installing the waterproofing membrane, a special attention should be paid to execution of complicated areas: internal and external corners, complicated joints, utilities passage, transitions from horizontal to vertical surface, etc. This is due to concentration of strains affecting the waterproofing membrane in such areas, or to eventual structural deformations, which can lead to the membrane rupture.

When installing the polymer-bitumen membrane, all complicated areas should be reinforced by specially cut pieces of the main waterproofing material, which are torched to the prepared base before applying the main layers of the waterproofing membrane.

NOTE: Installation of reinforcing elements enables additional hardening of the waterproofing material in the areas of complications and strains, permitting to augment reliability of the waterproofing membrane essentially.

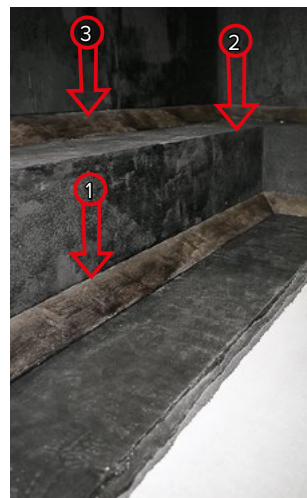

- The principle of installation of reinforcement strips does not differ from the principle of installation of the main waterproofing membrane, both onto a horizontal and onto a vertical surface. All overlapping rules, methods of torching and quality control are the same.
 - 1 – transition from the concrete blinding to the bedplate, p. 4.3.1.
 - 2 – change of directions over the bedplate, p. 4.3.2.
 - 3 – transition from the bedplate to vertical enclosing structures, p. 4.3.3.
 The reinforcement strip size is selected proceeding from the following conditions:

- at least **100 mm** in any direction from the element to be reinforced;
- roll width no more than **1 m**.

4.3.1. Transition from the concrete blinding to the bedplate

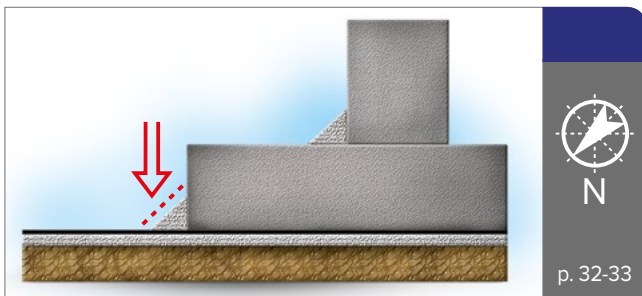

- Torch the reinforcement layer to the place of transition between concrete blinding and bedplate. For this purpose, check the reinforcement element on the spot and wind it into the roll in downward direction. Start the torching from the transitional fillet.



- Then torch the upper part of reinforcement element onto the bedplate.

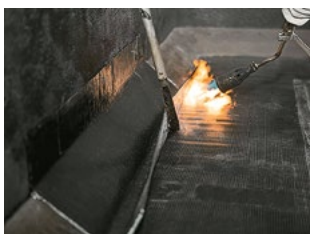

- Complete installation of the reinforcement strip by torching its lower part to the horizontal waterproofing membrane.



- Level the torched part of reinforcement strip with a silicone roller to prevent formation of folds and waves.



- One of the signs of the high-quality torching is the flowing out of bitumen mass from under the side edge of material as a compact bead, approximately for **5÷25 mm** (depending on material's thickness).

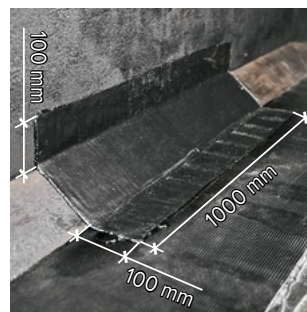

- Torch the reinforcement elements around the entire perimeter of the bedplate.

4.3.2. Change of directions over the bedplate

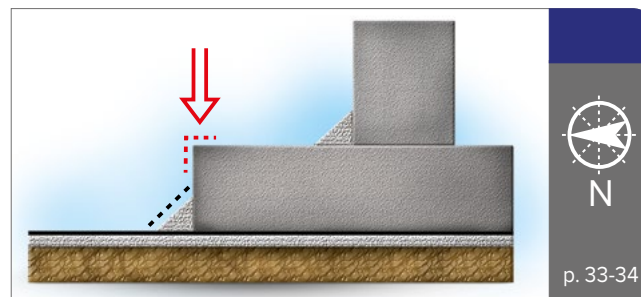



- Torch the reinforcement layer to the upper part of the bedplate in the place of change of direction from vertical to horizontal – to the vertical surface first.



- Then make the same in the upper part of horizontal surface.



- Level the torched reinforcement element with a silicone roller.

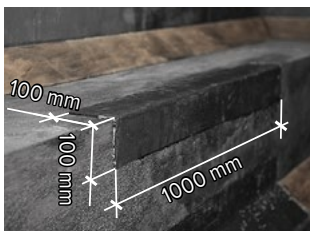

- Torch the reinforcement strips around the entire perimeter of the bedplate, with mandatory quality control of torching.

4.3.3. Transition from the bedplate to vertical enclosing structures

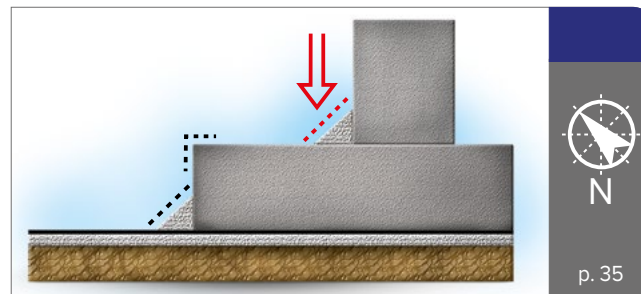

- Torch the reinforcement layer into the place of transition between bedplate and vertical enclosing structures. Torching is performed in a similar way to torching of the reinforcement layer in the place of transition between concrete blinding and bedplate (see p. 4.3.1.).



- Level the torched material with a silicone roller.

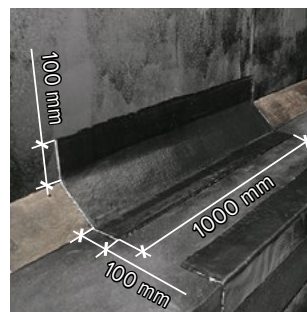

- Torch the reinforcement elements around the entire perimeter of the bedplate.

4.4. Installation of materials on vertical surfaces

NOTE: Pre-cut parts of the polymer-bitumen membrane of 2 m length are used for installation of the waterproofing layer on vertical surfaces.

4.4.1. Installation of the first layer of vertical waterproofing membrane

4.4.1.1. Installation of the first roll of the first layer

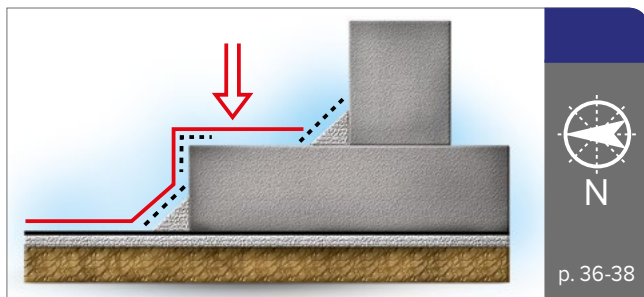

- Wind the prepared piece of material into a roll. It is recommended to perform roll winding on a metal pipe or cardboard core.



- Start torching from the lower point of the bedplate by rising up gradually.



- When performing the torching, install the rolls from **bottom-up** stage by stage, up to the height indicated in project documentation.

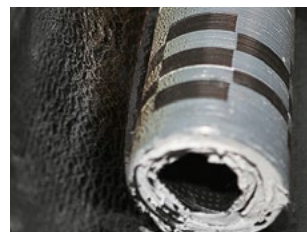

- Small flow-out of the bitumen mass in the place of contact of the roll with the base testifies to correct temperature conditions of torching.



- Torch the material onto the horizontal part of the bedplate and complete the material installation, by carefully melting the lower part of the roll of vertical waterproofing membrane to the horizontal membrane on the concrete blinding.

NOTE: It is not recommended to install the material in one roll when changing the installation direction for more than two times! In this case, cut the roll into shorter pieces.

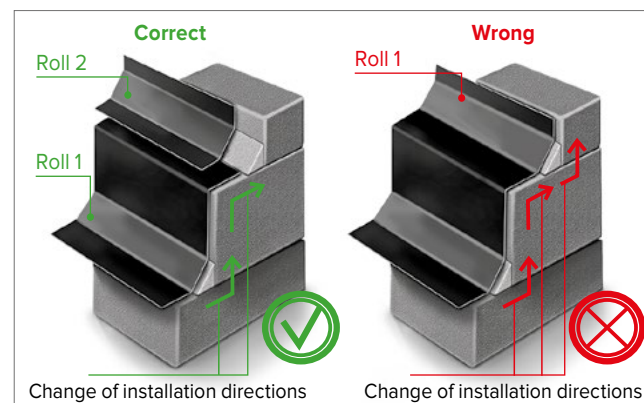



- Install in the same way the rolls of the first layer around the entire perimeter of the bedplate. Right before the torching, check the roll on the spot by ensuring the edge overlapping of at least **100 mm**.

4.4.1.2. Installation of the second roll of the first layer

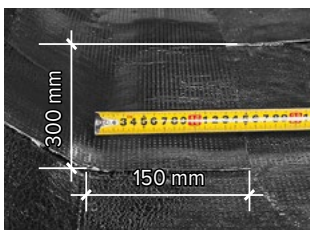
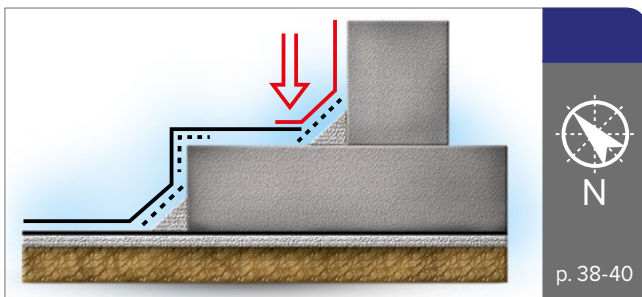

- Check the next roll/piece of the first layer in relation to the roll already installed. The end overlapping of the material, formed on the upper shelf of the bedplate, should be at least **150 mm**.

NOTE: The shift of the second roll of the first layer (torched on vertical surfaces of enclosing structures) from the edge of the first roll of the first layer (laid over the bedplate) should be equal to 300 mm.

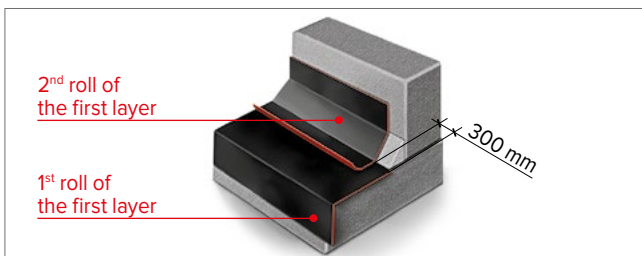

- Cut the roll corner that overlaps the lower roll. The corner cutting allows raising the quality of the weld by preventing unwelded spots.

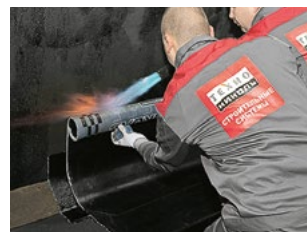

- Torch the roll onto the vertical surface, by unwinding the roll upwards gradually.



- Complete installation by carefully melting the lower part of the roll in the overlapping area.



- If necessary, torch the subsequent pieces of the material (**2 m** long) forming the first layer of the waterproofing membrane.



- It is mandatory to control the end overlapping (**150 mm**) and the roll corners cutting.



- Small amount of flow-out of bitumen on the roll edge testifies to correct temperature conditions of torching.



- Complete installation of the subsequent pieces of the material in the end overlapping area.

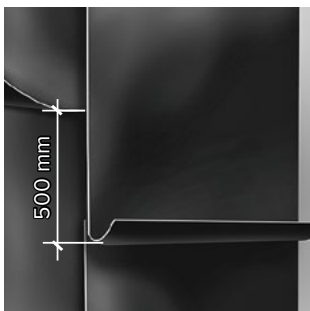

- When performing operations, consider that the spacing of end joints on vertical surface of contingent rolls of one layer should be at least **500 mm**.



- Perform installation of the first layer of vertical waterproofing membrane around the entire perimeter of the foundation. At first, perform operations for torching of the material onto the bedplate (around the entire perimeter of the whole structure) and then on vertical enclosing structures.

4.4.2. Installation of the second layer of vertical waterproofing membrane

4.4.2.1. Installation of the first roll of the second layer

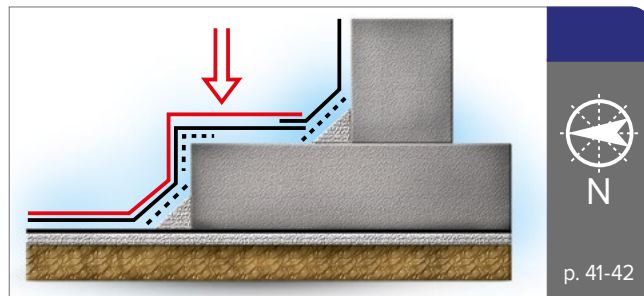

p. 41-42



- Torching of the second layer is carried out in the same way as for the first layer. At first, check the pre-cut part at place and wind it into a roll in downward direction.



- Start torching from the lower point of the bedplate by gradually unwinding the roll upwards.



- Perform torching of the second layer rolls onto the bedplate around entire perimeter of the whole structure carefully controlling all overlaps.

NOTE: The shift of the first roll of the second layer (laid over the bedplate) from the edge of the second roll of the first layer (torched on the vertical surfaces of enclosing structures) should be equal to 300 mm.

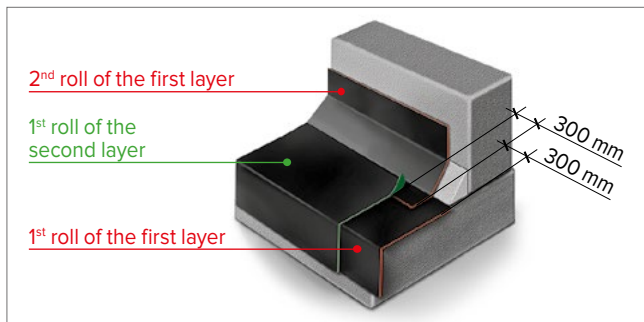

4.4.2.2. Installation of the second roll of the second layer

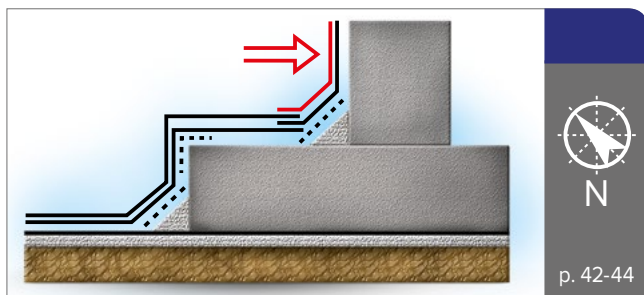

- Cut the roll corner that overlaps the lower roll.

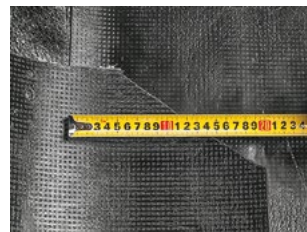

- The end overlapping of the second layer rolls, formed over the bedplate, should be at least **200 mm**.



- Torch the second layer roll onto the vertical surface.



- Perform installation of the second layer rolls onto vertical enclosing structures around the entire perimeter of the whole structure.

NOTE: The shift of the second roll of the second layer (torched on vertical structures) from the edge of the first roll of the second layer (laid over the bedplate) should be equal to 300 mm.

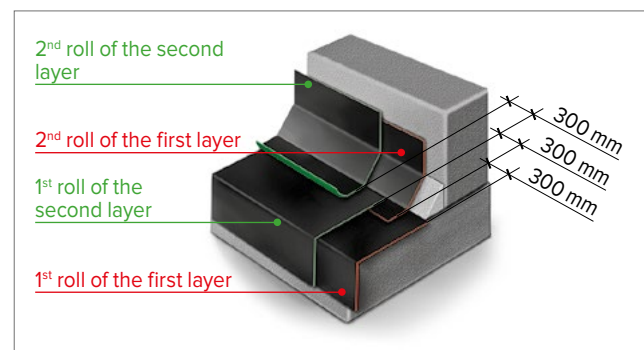

In case of correct execution of operations and observance of all recommendations, you should obtain the following:



- In the place of transition from the concrete blinding to the bedplate (**1** – horizontal membrane; **2** – reinforcement layer; **3** – first layer of the vertical membrane; **4** – second layer of the vertical membrane);

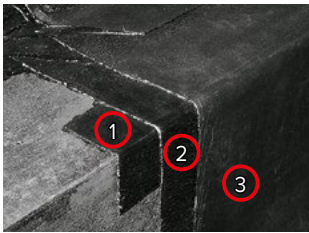

- In the upper point of the bedplate when changing the direction from vertical to horizontal (**1** – reinforcement layer; **2** – first layer of the vertical membrane; **3** – second layer of the vertical membrane);



- In the place of transition from the bedplate to the vertical enclosing structures (**1** – reinforcement layer; **2** – first layer of the vertical membrane; **3** – second layer of the vertical membrane).

5.

Execution of units and elements

5. Execution of units and elements

5.1. General information

When installing the waterproofing system, a special attention should be paid to execution of complicated areas: internal and external corners, complicated joints, utilities passage and expansion joint areas. It is recommended to start arranging the waterproofing membrane with such places.

5.2. Waterproofing membrane installation at the basement level

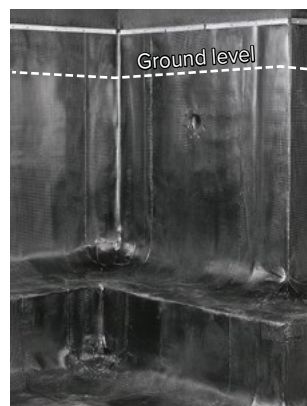

- Raise the waterproofing membrane to the altitude of **0.3-0.5 m** above the ground level.



- Mechanically fix the upper edge of waterproofing membrane to the structure at the basement level with a profiled metal edge strip.



- Fill in the space between the wall and the fold flange of the edge strip with a polyurethane sealant.



- Use a special tubular pistol for sealants in soft tubes for this purpose.

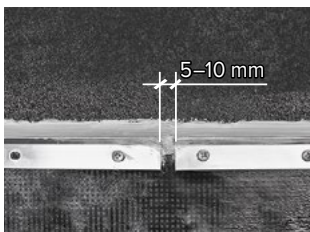

- Leave the expansion clearance of **5-10 mm** between contiguous fixing elements.

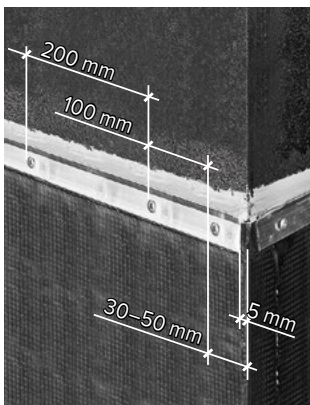

- Cut the edge strip in the places of internal or external corners. It is not permitted to bend the edge strip at the corners. Fix the edge of the strip at a distance no more than **5 mm** from the foundation corner. In the places of corners, the distance between the first and second self-tapping screws (counted from the corner) should be **100 mm**; all the subsequent self-tapping screws should be installed with a step of **200 mm**.

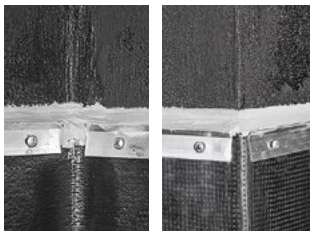

- In the places of interruption of the edge strip, apply the sealant in a continuous layer (without interruption along the edges of the strip).

5.3. Waterproofing of penetration piping



- Check whether the penetration piping is installed according to the design.



- Prepare the reinforcement element of polymer-bitumen membrane.

NOTE: The diameter of the hole in the reinforcement element should be equal to the internal diameter of penetration piping.



- Check it with the penetration piping.

NOTE: The reinforcement layer size should be equal to the external diameter of penetration piping + minimum 200 mm in each direction.



- Carefully torch the reinforcement layer by observing the general principles of torching.



- The torched element should have no folds, wrinkles and waves.



- Torch the first roll of the first layer of the waterproofing membrane. It should be noticed that the vertical joint should be approximately on the axis of the penetration piping (considering overlapping).

NOTE: It is necessary to make the holes for anchor bolts in the waterproofing membrane not before the material installation, but during this operation.



- Torch the second roll of the first layer. The edge overlapping of adjacent rolls should be at least **100 mm**.



- Torch the second layer of the waterproofing membrane. During this operation, the penetration piping should be at the middle of the roll.



- Start the clamping plate on bolts. Before definitive tightening of the bolts, apply a polyurethane sealant or extendable paste to the place of adjunction of the clamping plate to the waterproofing membrane.



- Also treat the anchor bolts with polyurethane sealant or extendable paste before tightening them. After that, tighten the bolts.

5.4. External corner waterproofing

5.4.1. Installation of the first reinforcement layer

5.4.1.1. Transition from the concrete blinding to the vertical surface of the bedplate

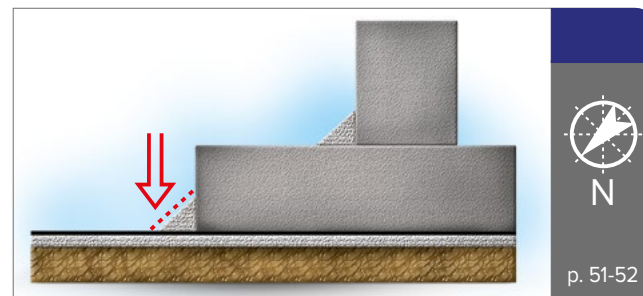

p. 51-52



- Prepare the reinforcement element of external corner for the place of transition from the concrete blinding to the vertical surface of the bedplate. At first, cut a piece of material and check it on the spot.



- Perform torching of the reinforcement element.



- Level the torched material with a silicone roller.



- The reinforcement element should be torched properly. One of the signs of the high-quality torching is the flowing out of bitumen mass from under the lateral edge of material as a compact bead, approximately for **5÷25 mm** (depending on material's thickness).

5.4.1.2. Vertical surface of the bedplate

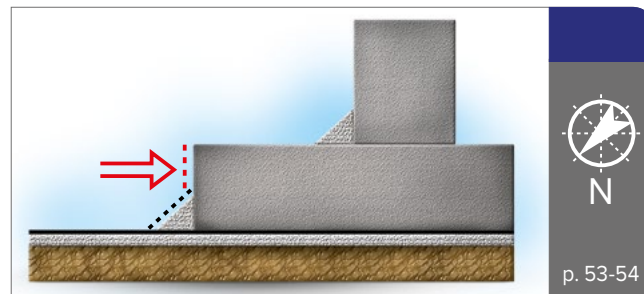

p. 53-54



- Prepare the reinforcement element of external corner over the bedplate. At first, cut a piece of material and check it on the spot.



- Torch one side of the reinforcement element first.



- Then torch the second side of the reinforcement element.



- Carefully torch the lower part of the reinforcement element in the transition place.



- Complete torching of the upper part of the reinforcement element.



- Properly installed reinforcement element should look as follows.

5.4.1.3. Transition from the horizontal surface of the bedplate to vertical enclosing structures

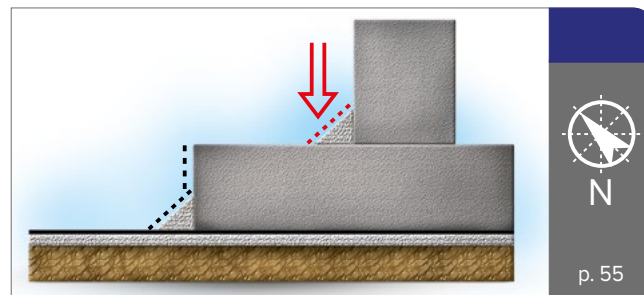

p. 55

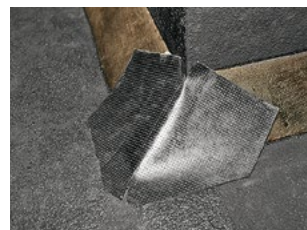

- Prepare the reinforcement element of external corner for the place of transition from the horizontal surface of the bedplate to the vertical surface of enclosing structure. At first, cut a piece of material and check it on the spot.



- Perform torching of the reinforcement element.



- The torched element should look as follows.

5.4.1.4. Vertical surface of enclosing structure

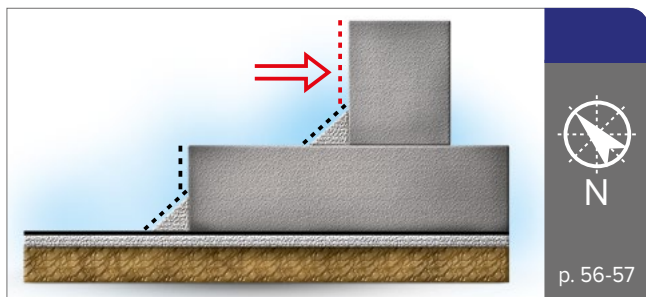

- Prepare the reinforcement element of external corner for the enclosing structure. At first, cut a piece of material and check it on the spot.



- Torch one side of the reinforcement element first.

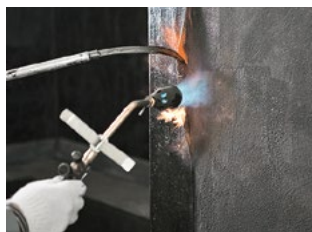

- Then torch the second side of the reinforcement element.



- In order to avoid formation of folds and waves, level the torched material with a silicone roller.

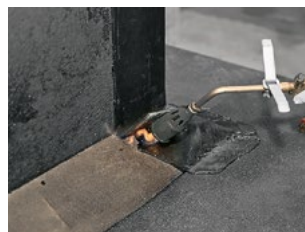

- Carefully torch the lower part of reinforcement element in the transition place.



- Properly installed reinforcement element in the place of transition from the bedplate to the enclosing structure should look as follows.

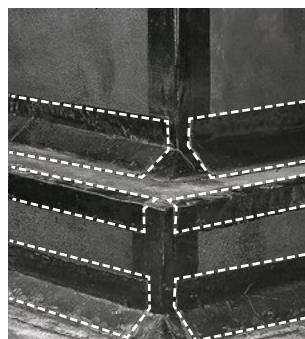

- Upon completion of the operations for external corner reinforcement, torch the reinforcement layers onto the ordinary surface (see **p. 4.3.**).

5.4.2. Installation of the first layer of vertical waterproofing membrane

5.4.2.1. Installation of the first roll of the first layer

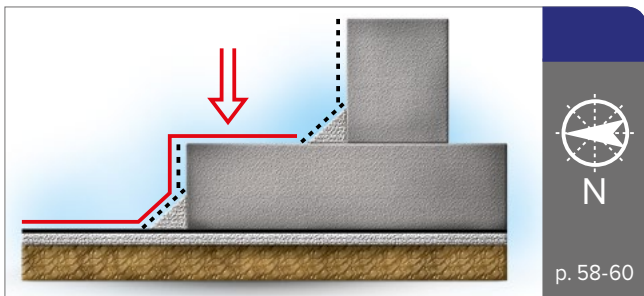

- Check the first layer of the vertical waterproofing membrane so that one of the lower corners of the vertical membrane should coincide with the corner of the horizontal membrane (in the picture it is the right-hand corner). Cut off the extra part of the material at the bedplate level with a roofing knife. In the place of transition of the roll to the concrete blinding, perform the cut diagonally to the roll corner.



- Wind the prepared material into a roll in downward direction and torch it carefully.



- The torched roll should look as follows: **1** – horizontal membrane; **2** – first layer of the vertical membrane; **3** – external corner reinforcement; **4** – reinforcement on ordinary surface.

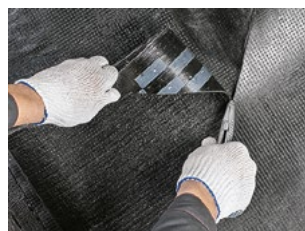

- Check and cut the adjacent roll.



- Wind the prepared material into a roll and torch it carefully.



- The torched rolls of the first layer should look as follows.

NOTE: Do not forget about the rule that is not permitted to torch the material in one roll when changing the installation direction for more than two times. In this case, cut the roll into shorter pieces.



- Torch the first layer rolls of vertical waterproofing membrane in the area of concrete blinding – bedplate transition around the entire perimeter of the whole structure, by observing all rules of torching onto a vertical surface (overlaps, flow-out of bitumen, etc.).

5.4.2.2. Installation of the second roll of the first layer

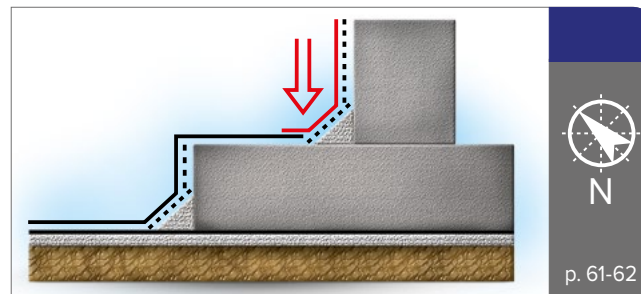

p. 61-62



- Check the first layer of vertical waterproofing membrane in the place of transition between bedplate and vertical enclosing structures so that the membrane overlapping over the bedplate should make **150 mm**. In the place of transition of the waterproofing membrane to the bedplate, cut the roll diagonally to its corner.

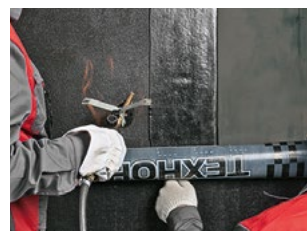

- Wind the material into a roll and torch one side of it onto the structure in the direction from bottom to top.



- After the torching, cut off the free (not torched) side of the roll with a roofing knife up to the bedplate level.



- Prepare the second roll in a similar way and perform its torching.



- Cut the non-torched part of the roll up to the bedplate level.

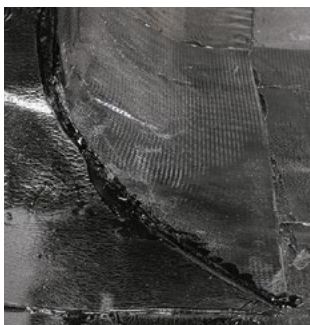

- The torched rolls should look as follows. After that, perform torching of the first layer of vertical waterproofing membrane around the entire perimeter of the whole structure.

5.4.3. Installation of the second reinforcement layer

5.4.3.1. In the concrete blinding area

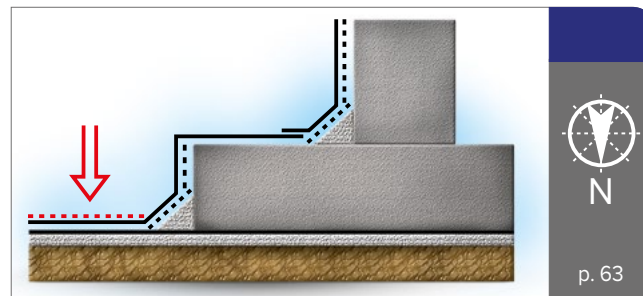

p. 63



- Check and trim the reinforcement element with the concrete blinding. The reinforcement layer size should be at least **200 mm**: **100 mm** in each direction from the junction of the first layer rolls.

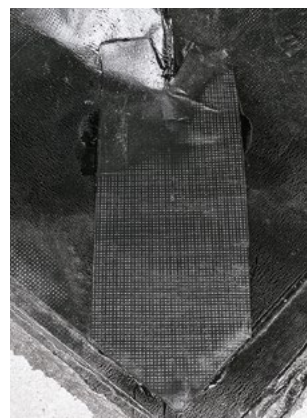

- Torch the reinforcement layer by observing the general principles of torching.

5.4.3.2. Transition from the concrete blinding to the bedplate

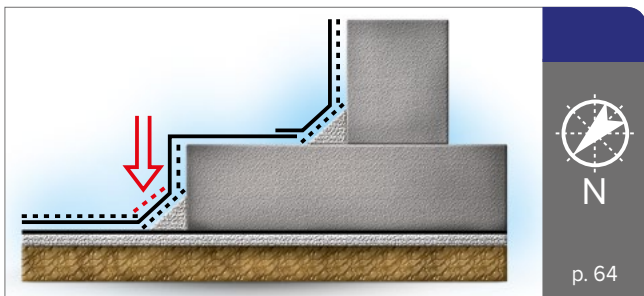

- Prepare and torch the reinforcement element in the area of transition from the concrete blinding to the vertical part of the bedplate by observing the general principles of torching and size requirements for the reinforcement layer indicated above.

5.4.3.3. Vertical surface of the bedplate

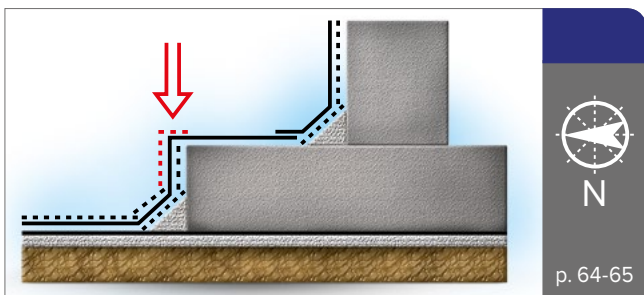

- Prepare and torch the reinforcement element on the vertical part of the bedplate. First, torch one side, then the other side by observing the general principles of torching and size requirements for the reinforcement layer indicated above.

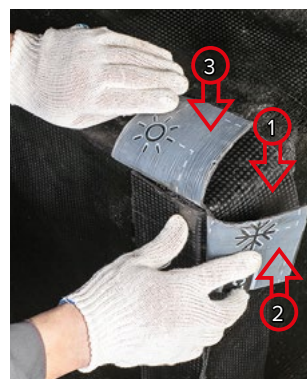

- Prepare and torch another reinforcement element in the place of transition of the bedplate from vertical to horizontal: **1** – at first, torch the upper part; **2** – then the lateral cut; **3** – then the upper cut.



- Properly installed reinforcement element in the place of transition from the concrete blinding to the bedplate should look as follows.

5.4.3.4. Horizontal surface (upper shelf) of the bedplate

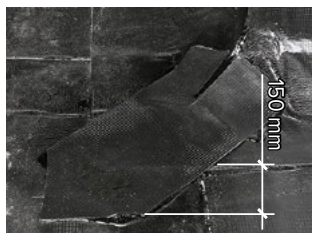
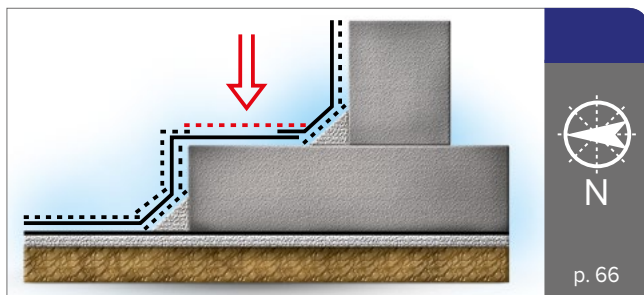

- Prepare and torch the reinforcement element on the horizontal surface of the bedplate. The reinforcement element should protrude outside the limits of overlapping of the vertical membrane for **150 mm**.

5.4.3.5. Transition from the horizontal surface of the bedplate to the vertical enclosing structures

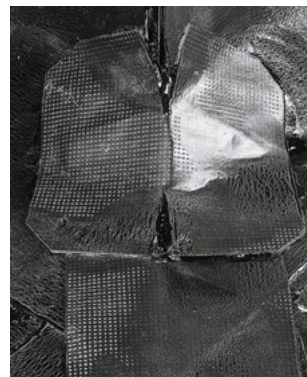
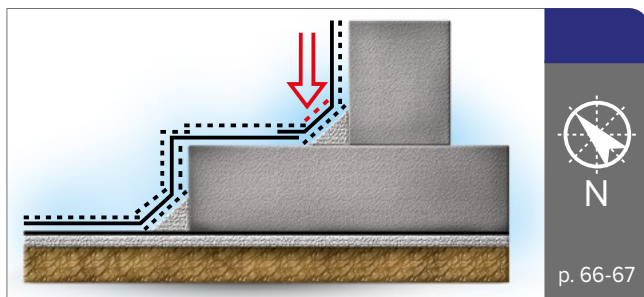

- Prepare and torch the reinforcement element in the place of transition from the horizontal surface of the bedplate to the vertical enclosing structures. The reinforcement layer size should be at least **200 mm: 100 mm** in each direction from the junction of the first layer rolls.

5.4.3.6. Vertical surface of the enclosing structure

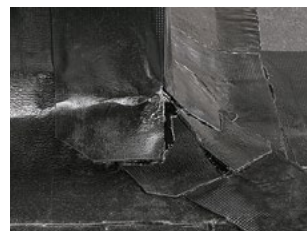
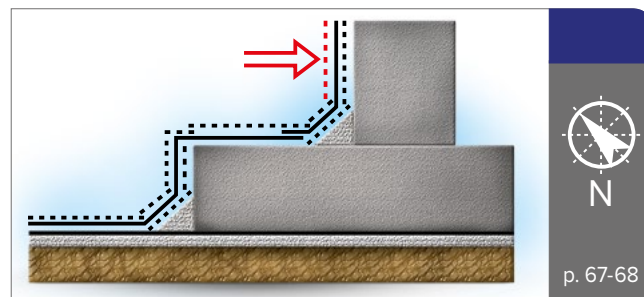

- Prepare and torch the reinforcement element on the vertical enclosing structures by observing the general principles of torching and size requirements for the reinforcement layer indicated above.



- General view of the first layer of vertical waterproofing membrane with the second reinforcement layer of external corner.

5.4.4. Installation of the second layer of vertical waterproofing membrane

5.4.4.1. Installation of the first roll of the second layer

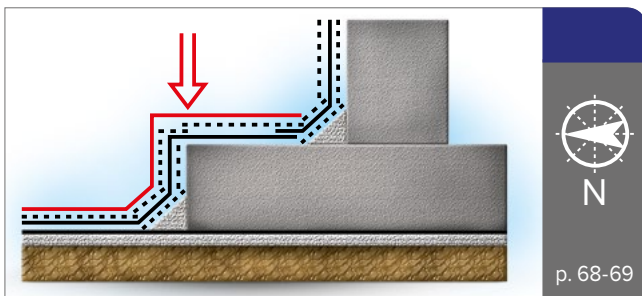

- Perform torching of the second layer of vertical waterproofing membrane in the external corner area according to the technology described above (see p. 5.4.2.1.).



- Then torch the second layer of waterproofing membrane around the entire perimeter of the bedplate.

5.4.4.2. Installation of the second roll of the second layer

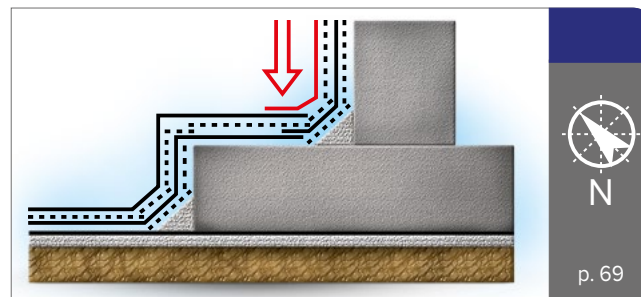

- Perform torching of the second layer of waterproofing membrane in the external corner area on the vertical enclosing structures according to the technology described above (see p. 5.4.2.2.).



- Then perform torching of the second layer of waterproofing membrane on the vertical enclosing structures around the entire perimeter of the whole structure.

5.4.5. Installation of the third reinforcement layer

5.4.5.1. On the concrete blinding – Transition from the concrete blinding to the vertical part of the bedplate – Vertical surface of the bedplate

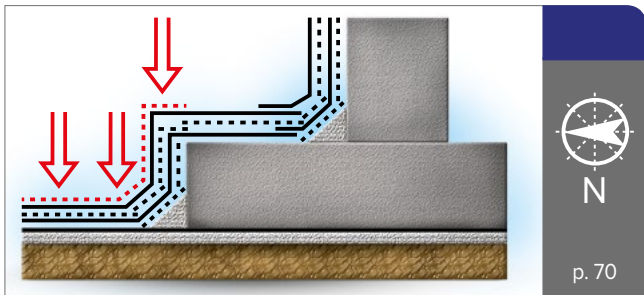

- Prepare and torch the reinforcement elements by observing the general principles of torching and technology mentioned in p. 5.4.3. The reinforcement layer size should be at least **200 mm: 100 mm** in each direction from the junction of the second layer rolls.



- Properly installed reinforcement element in the bedplate area should look as follows.

5.4.5.2. Horizontal surface of the bedplate – Transition from the bedplate to the vertical enclosing structures – Vertical enclosing structures

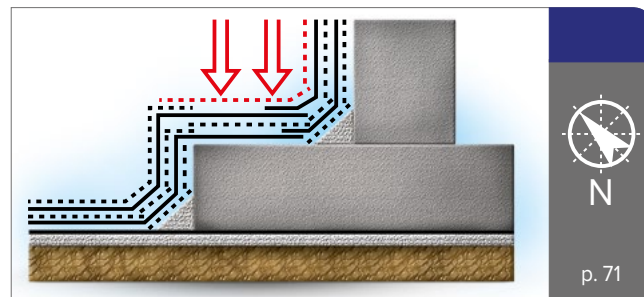

- Install the reinforcement elements in the area of transition from the horizontal surface of the bedplate to the vertical enclosing structures by observing the general principles of torching and technology mentioned in p. 5.4.3. The reinforcement layer size should be at least **200 mm: 100 mm** in each direction from the junction of the second layer rolls.

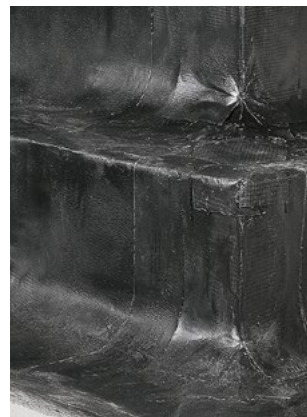

- The finished external corner should look as follows.

5.5. Internal corner waterproofing

5.5.1. Installation of the first reinforcement layer

5.5.1.1. Transition from the concrete blinding to the bedplate

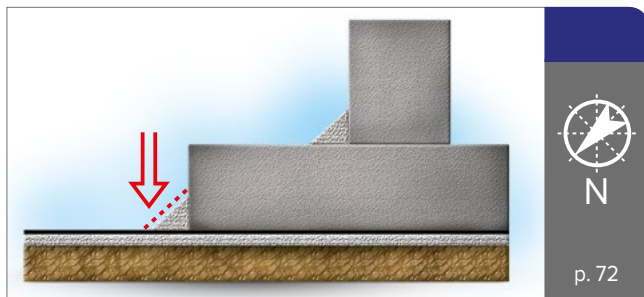

- Prepare the reinforcement element of internal corner for the place of transition from the concrete blinding to the vertical surface of the bedplate. At first, cut a piece of material and check it on the spot.



- Torch the reinforcement element.



- The reinforcement element should be torched properly. One of the signs of the high-quality torching is the flowing out of bitumen mass from under the lateral edge of material as a compact bead, approximately for **5÷25 mm** (depending on material's thickness).

5.5.1.2. Vertical surface of the bedplate

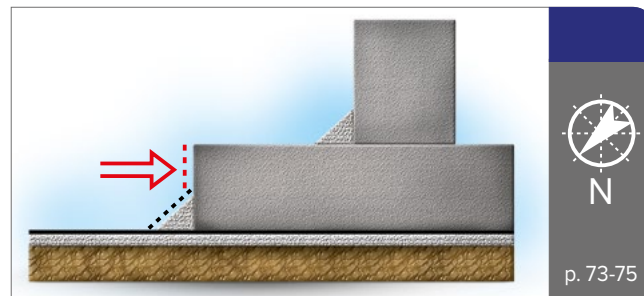

- Prepare the reinforcement element of internal corner over the vertical surface of the bedplate. At first, cut a piece of material and check it on the spot.



- Torch one side of the reinforcement element first.



- Then torch the second side of the reinforcement element.



- Carefully torch the lower part of the reinforcement element in the transition place.



- Torch the upper part of the reinforcement element.

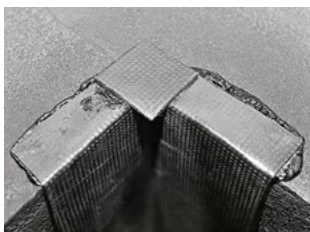

- Reinforce the free area of the corner with a butt.



- Torch it onto the reinforcement element by carefully folding the protruding part into the corner.



- Properly installed reinforcement element should look as follows.

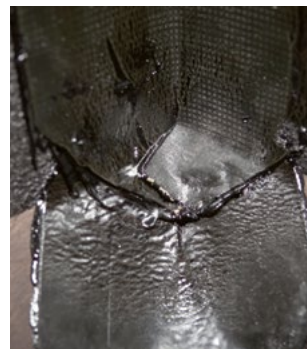

- Properly installed reinforcement element should look as follows.

5.5.1.3. Transition from the horizontal surface of the bedplate to the vertical enclosing structures

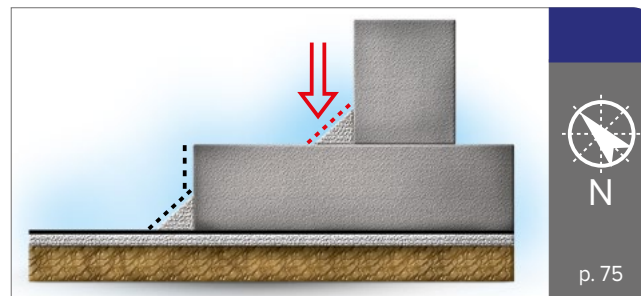

p. 75



- Perform the internal corner reinforcement in the place of transition from the horizontal surface of the bedplate to the vertical surface of enclosing structure.

5.5.1.4. Vertical surface of enclosing structure

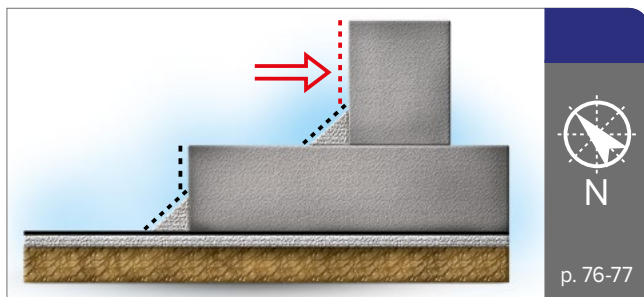

- Torch the reinforcement element onto the enclosing structure.

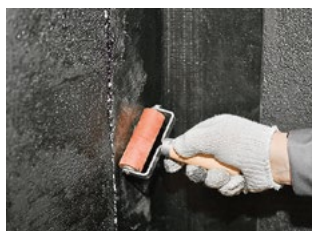

- In order to avoid formation of folds and waves, level the torched material with a silicone roller.



- Carefully torch the lower part of reinforcement element in the transition place.



- Properly installed reinforcement element in the place of transition from the bedplate to the enclosing structure should look as follows.

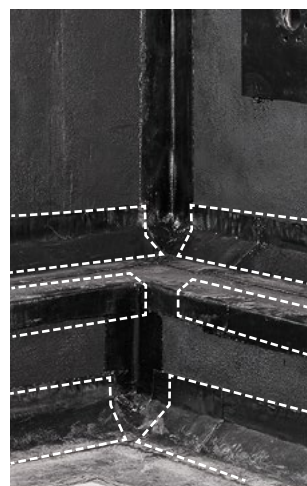

- Upon completion of the operations for internal corner reinforcement, torch the reinforcement layers onto the ordinary surface (see p. 4.3.).

5.5.2. Installation of the first layer of vertical waterproofing membrane

5.5.2.1. Installation of the first roll of the first layer

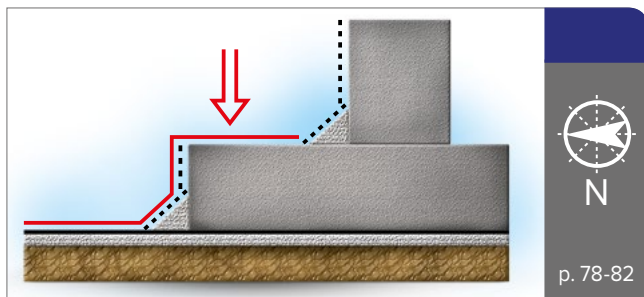

- Check the first layer of vertical waterproofing membrane so that one edge of the roll should coincide precisely with the internal corner over the bedplate. In the place of transition of the roll to the concrete blinding, perform the cut diagonally.



- Wind the prepared material into a roll in downward direction.



- Start torching onto the horizontal surface of concrete blinding, by gradually unwinding the roll upwards.



- Properly installed first roll should look as follows.



- Check and cut the adjacent roll.



- Wind the prepared material into a roll in downward direction and torch it from bottom to top.



- The torched rolls of the first layer should look as follows.

NOTE: Do not forget about the rule that is not permitted to torch the material in one roll when changing the installation direction for more than two times. In this case, cut the roll into shorter pieces.



- It is necessary to put a patch on the corner area without torched material formed over the bedplate.

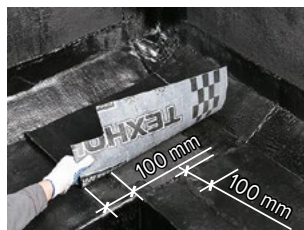

- Measure and cut the patch on the spot. Edge overlapping on the waterproofing membrane should be at least **100 mm**.



- Torch the prepared patch.



- Properly installed patch should look as follows. After that, torch the first layer rolls of the vertical waterproofing membrane in concrete blinding – bedplate area around the entire perimeter of the whole structure.

5.5.2.2. Installation of the second roll of the first layer

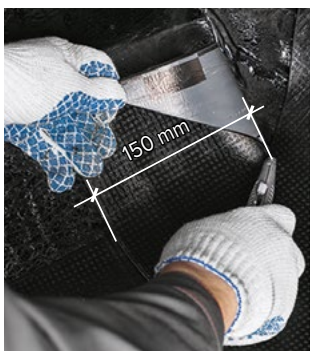
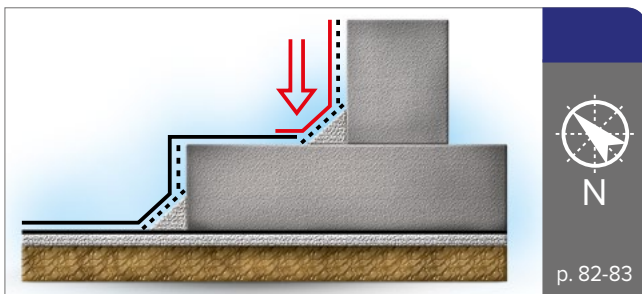

- Check the first layer of vertical waterproofing membrane in the place of transition between bedplate and vertical enclosing structure so that the membrane overlapping over the bedplate should make **150 mm**. In the place of transition of the roll to the bedplate, cut the roll diagonally.

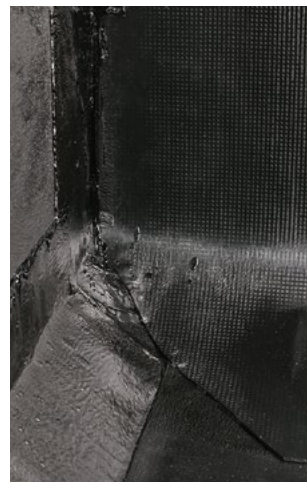

- Wind the material into a roll and torch it onto the structure in the direction from bottom to top.



- Prepare the second roll in a similar way and perform its torching.



- Properly installed rolls should look as follows. After that, perform torching of the first layer of vertical waterproofing membrane on the vertical enclosing structures around the entire perimeter of the whole structure.

5.5.3. Installation of the second reinforcement layer

5.5.3.1. In the concrete blinding area

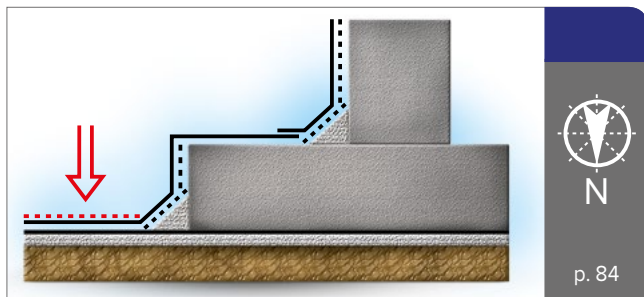

- After installation of the first layer of vertical waterproofing membrane, install the second reinforcement layer of internal corner. Check and trim the reinforcement element in the concrete blinding area. The reinforcement layer size should be at least **200 mm: 100 mm** in each direction from the junction of the first layer rolls.

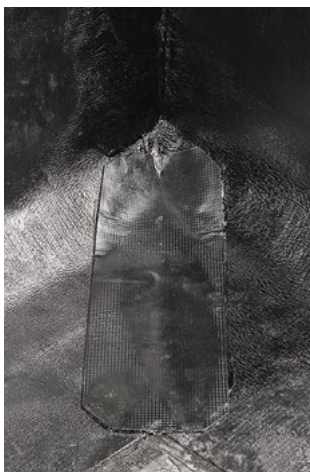

- Torch the reinforcement layer carefully.

5.5.3.2. Transition from the concrete blinding to the bedplate

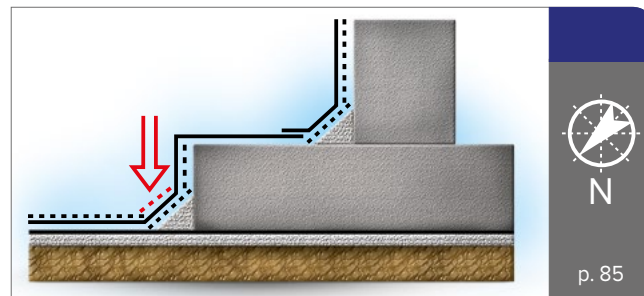

- Prepare the reinforcement element for the area of transition from the concrete blinding to the vertical part of the bedplate.



- Torch it carefully. Torch the trimmed parts with overlapping over each other.

5.5.3.3. Vertical surface of the bedplate

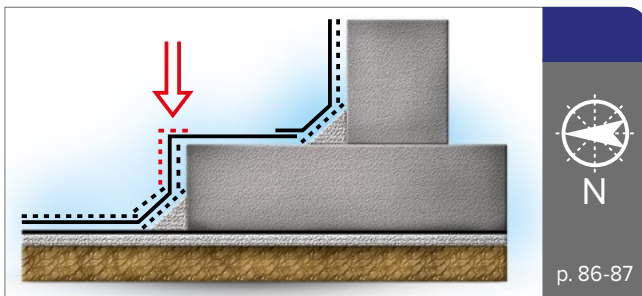

- Prepare and torch the reinforcement element on the vertical part of the bedplate by observing the general principles of torching and size requirements for the reinforcement layer indicated above.



- Trim the reinforcement element in the upper part of the bedplate.

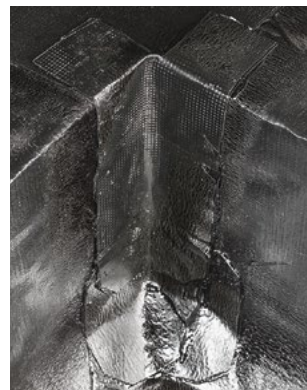

- Properly installed reinforcement element should look as follows.

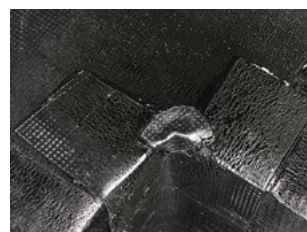

- Torch a butt in the upper point of the reinforcement element.

5.5.3.4. Horizontal surface (upper shelf) of the bedplate

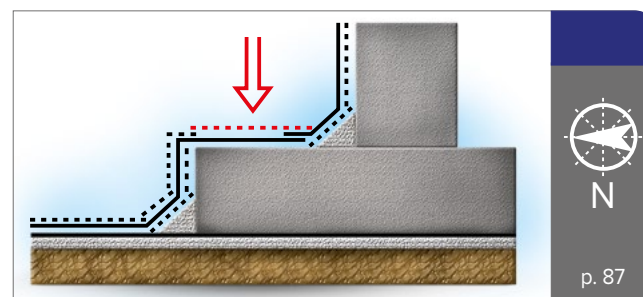

- Prepare and torch the reinforcement element on the horizontal surface of the bedplate. In the place of passing to the vertical part, trim the reinforcement element in order to avoid wrinkling.

5.5.3.5. Transition from the horizontal surface of the bedplate to the vertical enclosing structures

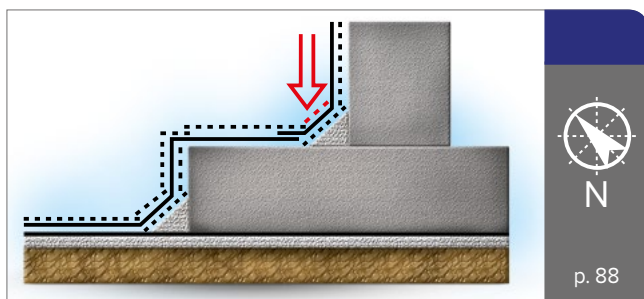

- Prepare the reinforcement element for the place of transition from the horizontal surface of the bedplate to the vertical enclosing structures.



- Torch the trimmed pieces of the reinforcement element upon each other to avoid wrinkling.

5.5.3.6. Vertical surface of enclosing structure

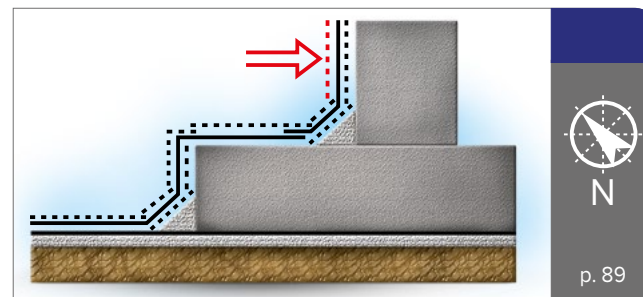

- Prepare and torch the reinforcement element on the vertical enclosing structures by observing the general principles of torching and size requirements for the reinforcement layer indicated above.



- General view of the internal corner with the first layer of vertical waterproofing membrane and the second reinforcement layer.

5.5.4. Installation of the second layer of vertical waterproofing membrane

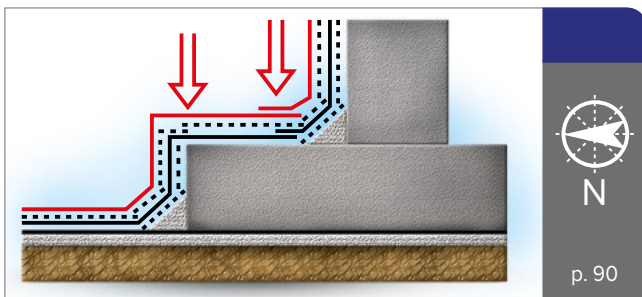

- Perform torching of the second layer of vertical waterproofing membrane in the internal corner area, over the bedplate first. Then torch the second layer of waterproofing membrane around the entire perimeter of the whole structure over the bedplate. After that, perform torching of the second layer of waterproofing membrane in the internal corner area on the vertical enclosing structures and torching of the second layer of waterproofing membrane on the vertical enclosing structures around the entire perimeter of the whole structure.

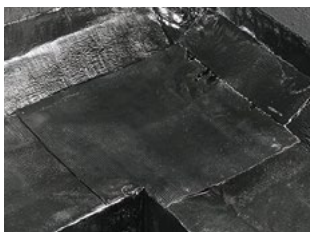

- Perform all operations by observing the general principles of torching and technology mentioned in p. 5.5.2.

5.5.5. Installation of the third reinforcement layer

5.5.5.1. On the concrete blinding – Transition from the concrete blinding to the vertical part of the bedplate – Vertical surface of the bedplate

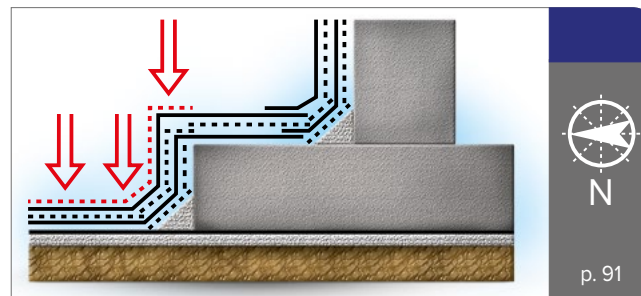

- Upon completion of the operations for installation of the second layer of vertical waterproofing membrane, arrange the last (third) reinforcement layer of the internal corner in the concrete blinding – bedplate area.



- Perform all operations by observing the general principles of torching and technology mentioned in p. 5.5.3.

5.5.5.2. Horizontal surface of the bedplate – Transition from the bedplate to the vertical enclosing structures – Vertical enclosing structures

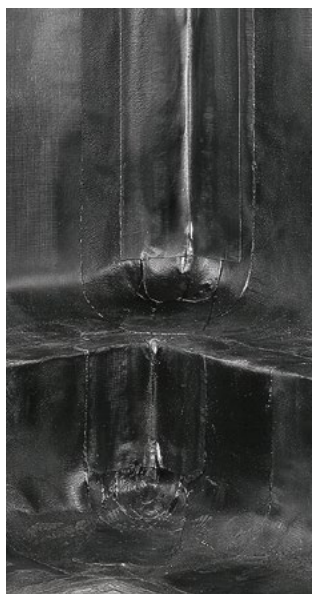
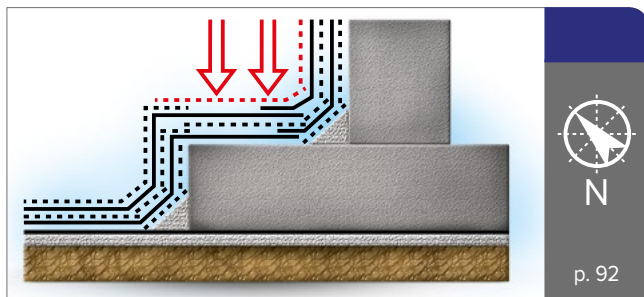

- Prepare and torch the reinforcement elements on the horizontal surface of the bedplate in the area of transition from the horizontal surface of the bedplate to the vertical enclosing structures, as well as on the vertical enclosing structures.
- Perform all operations by observing the general principles of torching and technology mentioned in **p. 5.5.3.**
- The finished internal corner should look as follows.

5.6. Expansion joint sealing

NOTE: There may be different variants of installation of the waterproofing membrane in the area of expansion joints. It depends on the type of expansion joint, type of applied materials for its sealing, etc. In this instruction, we show only one most common variant. For further details, please check the project documentation.

5.6.1. General principles of installation of the waterproofing membrane in the expansion joint area



- Start installation of the waterproofing membrane in the expansion joint area only after full drying of the bitumen primer.

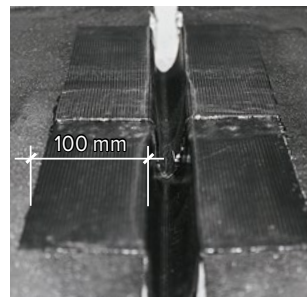

- The expansion joint with a compensating loop should look as follows. The size of the piece of the material for torching onto the concrete blinding should be at least **100 mm** in each direction.

5.6.2. Expansion joint sealing in the place of its transition from the vertical to horizontal surface

NOTE: Start installation of the waterproofing membrane in the expansion joint area from the places of joint transition from the horizontal to vertical surface.



- Seal the expansion joint transition from vertical to horizontal by means of a special joint made of waterproofing polymer-bitumen membrane and prepared in situ.



- The joint consists of two parts: upper (1) and lower (2).



- Torch the two parts one to another, as shown on the figure.



- At the outer side of the joint, torch a butt for additional sealing of the joint.



- The joint with torched butt should look as follows.



- Check the ready joint on the spot. Trim it if necessary.

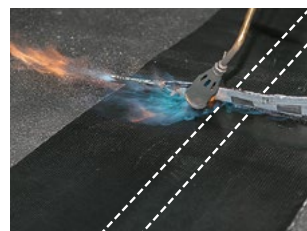

- Torch the prepared joint to the roll of the material that seals the horizontal deformation joint with overlapping of **150 mm**. Then do the same for the vertical surface.



- Torch one part of the roll (at one side of the expansion joint) onto the base, form the compensating loop, then torch the second part of the roll onto the base.



- The compensating loop can be formed by using the material wound into the roll.



- If necessary, level the torched material with a silicone roller.

5.6.3. Installation of the first layer of waterproofing membrane in the expansion joint area

NOTE: The bedplate expansion joint must coincide with the expansion joint in the concrete blinding on which the horizontal waterproofing membrane is installed.

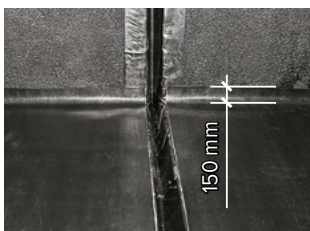

- Start torching of the rolls from the expansion joint in both directions. At first, unwind and check the rolls on the spot. Provide overlapping of the horizontal membrane rolls onto the vertical surface to the height of at least **150 mm**.

NOTE: If necessary, install the reinforcement strips in the place of transition from the vertical to horizontal surface.



- Wind the material into a roll and torch it by observing the general principles of torching.



- Small amount of flow-out of bitumen on the roll edge testifies to high quality torching of the material.



- Perform torching of the first layer of vertical waterproofing membrane in a similar way.

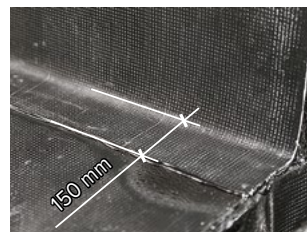

- Provide overlapping of the vertical rolls onto the horizontal surface to the distance of at least **150 mm**.

5.6.4. Installation of the second layer of compensating loop

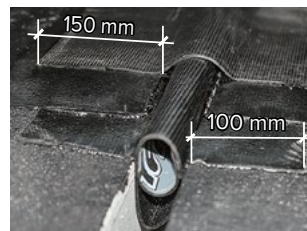

- After installation of the first layer of waterproofing membrane, perform torching of the second layer of compensating loop. The reinforcement layer size should be at least **150 mm** in each direction from the joint axis.

NOTE: Depending on the operation conditions of the structure, the roll, which forms the compensating loop, can be either completely submerged in the seam hollowness or be visible over the surface.

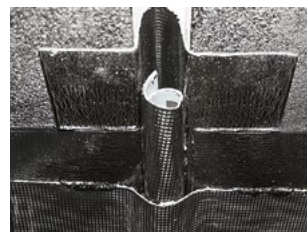

- Install the second layer of compensating loop on the vertical surface.

NOTE: The reinforcement layer is torched only in the places of joining with the first layer of waterproofing membrane and is not torched in the place of expansion joint.



- In the place of transition from vertical to horizontal surface, install the compensating loop with overlapping onto the opposite surface (provide overlapping of the horizontal reinforcement layer onto the vertical surface and vice versa).

5.6.5. Installation of the second layer of waterproofing membrane in the expansion joint area

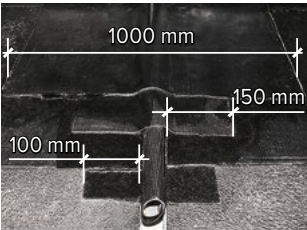

- Install the second layer of waterproofing membrane by complete torching to the first layer.

NOTE: Start installation of the second layer of waterproofing membrane by torching the first roll in the middle of the expansion joint.



- Torch the subsequent rolls of the second layer with edge overlapping of at least **100 mm**.

6.

Protection of the waterproofing membrane

6. Protection of the waterproofing membrane

6.1. Protection with PLANTER standard profiled HDPE membrane



- Fix the profiled HDPE membrane with conic studs towards the enclosing structure by means of concrete nails or self-tapping screws with clamping washers.



- PLANTER standard profiled HDPE membrane is fixed at the basement level with a distance of **200-300 mm** from the waterproofing membrane.

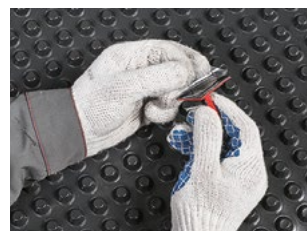

- If necessary, perform intermediate fixing of the profiled membrane at its height by using a mechanical fixture attached directly to the waterproofing membrane. To install the fixture, it is necessary to remove the protective film on its platform and stick the fixture to the waterproofing membrane.



- Unwind smoothly the roll of profiled membrane fixed at the basement level in downward direction.

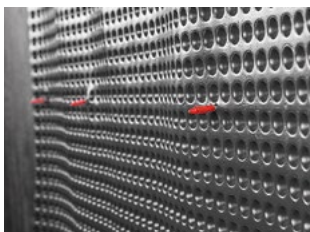

- Pierce through the roll of profiled membrane with the tip of the fixture.



- The lateral overlapping of adjacent rolls should make at least **4 studs**.



- Seal the obtained joint with NICOBAND self-adhesive sealant tape of **150 mm** wide. Do it by removing the protective film carefully from the self-adhesive surface of the tape, gradually unwinding the roll from top to bottom and smoothing it by hand.

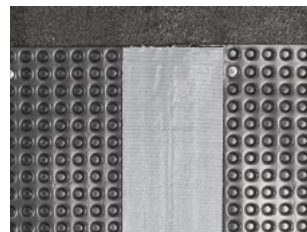

- The joint sealing is necessary to avoid outside elements (ground, waste etc.) in the profiled membrane in the course of further operations.



- Cover the upper edge of the fixed profiled HDPE membrane with an edge profile.

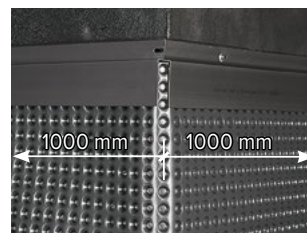

- Cover the external corners with whole rolls so that there should be a strip at least **1 m** wide in both directions from the corner.

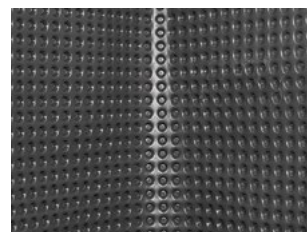

- The same applies to the internal corner installation.

6.2. Protection with PLANTER geo profiled HDPE membrane used for wall drainage



- Prepare the rolls of PLANTER geo profiled HDPE membrane for installation. For this purpose, take off the geotextile carefully from the edges of contiguous rolls for a width of **4-6 studs**.



- The overlapping of contiguous rolls of the profiled membrane should make **70-100 mm**.



- Take off the geotextile carefully from the profiled membrane at the butt ends forming the upper edge of the wall drainage. Cut off the separated part of HDPE membrane by the entire width of the roll. The free part of geotextile should make **70-100 mm**.



- The wall drainage can be fixed at the basement level with double-sided self-adhesive sealant tape NICOBAND DUO **150 mm** wide. For this purpose, stick the tape at the level of **200-300 mm** above the waterproofing membrane.



- Or else, fix the profiled membrane mechanically.



- Seal the places of the future vertical junction of contiguous rolls with double-sided self-adhesive sealant tape NICOBAND DUO **150 mm** wide. Do it by removing the protective film carefully from the lower self-adhesive surface of the tape, gradually unwinding the roll from top to bottom and smoothing it by hand.

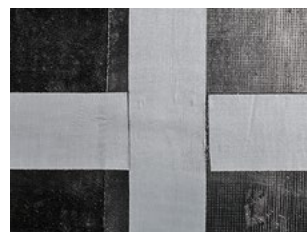

- If the intermediate fixing of the wall drainage at height is required, attach NICOBAND DUO tape **150 mm** wide in the respective places.



- Start fixing the rolls of profiled membrane from the upper point (basement level). At first, remove the upper protective film of NICOBAND DUO.



- Fix PLANTER geo profiled HDPE membrane with double-sided self-adhesive sealant tape NICOBAND DUO at the basement level.



- After that, wind up the roll of the profiled membrane upwards. In the place of vertical junction of contiguous rolls, remove the upper film of NICOBAND DUO and gradually unwind the wall drainage roll downwards.



- In the places of intermediate fixing of wall drainage at height, remove the upper protective film of NICOBAND DUO and continue unwinding the roll downwards.

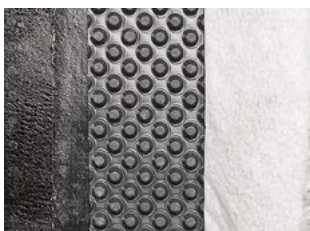

- Unwind the whole roll of PLANTER geo downwards by carefully pushing the places of adhesion of the profiled membrane to NICOBAND DUO sealant tape.



- Seal the place of junction of two contiguous rolls with NICOBAND DUO **75 mm** wide.



- Remove the upper protective film of the sealant tape and fix the next roll of the profiled membrane at the basement level with overlapping width of **4-6 studs**.



- Unwind the roll downwards by carefully pressing the places of overlapping and intermediate fixing.



- In the place of junction of two rolls of the profiled membrane, provide an overlapping of the free edge of geotextile onto the contiguous roll.



- Seal the place of junction of two geotextile sheets with double-sided self-adhesive sealant tape NICOBAND DUO **75 mm** wide or regular double-sided adhesive tape. Remove the upper protective film of the sealant tape.



- Stick the geotextile sheet of the contiguous roll to the sealant tape.

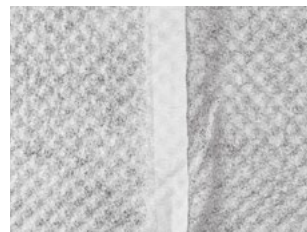

- Carefully smooth the places of joints of geotextile sheets by hand for their better adhesion.

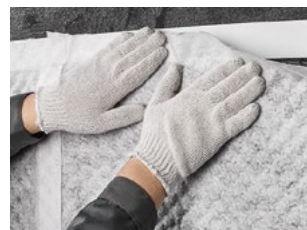

- Stick the upper free part of geotextile sheet to double-sided self-adhesive sealant tape NICOBAND DUO **75 mm** wide or regular double-sided adhesive tape.

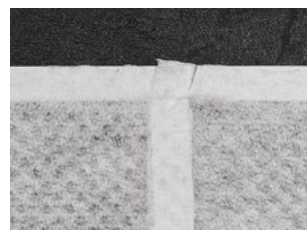

- This operation is required to avoid outside elements (ground, waste etc.) in the drainage system.



- Complete installation of the wall drainage at the basement level by installing the edge profile.

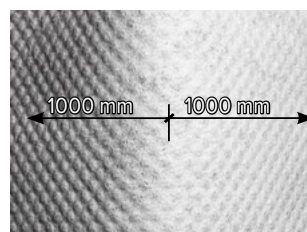

- Cover the external and internal corners with whole rolls so that there should be a strip at least **1 m** wide in both directions from the corner.



- While protecting the external corners with PLANTER standard and PLANTER geo, it is necessary to keep the profiled membrane edge parallel to the corner of the structure. For this purpose, stretch the upper edge of the membrane and only after that fix it to the base. Otherwise, there will be warping of the profiled membrane.



- Connect the wall drainage to the pipe drains installed around the perimeter of the structure, arrange the drain fills. Install the inspection and drop wells according to the design.

6.3. Protection with XPS TECHNINICOL CARBON



- Fix the extruded polystyrene slabs TECHNINICOL CARBON to the waterproofing membrane by means of attaching mastic TECHNINICOL No.27.



- For this purpose, apply the mastic with a spatula in **5 points** on XPS slab and stick it to the waterproofing membrane.



- XPS slabs can also be installed using mechanical fixtures.

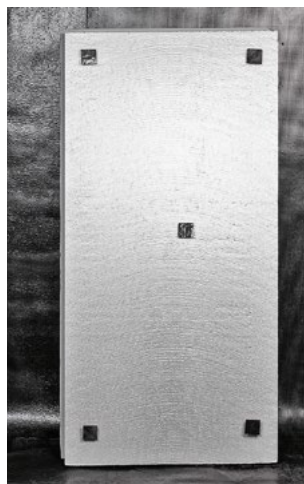

- There should be at least **5 fixtures** per TECHNINICOL CARBON XPS slab. It is possible to install the fixtures on the waterproofing membrane first and then fix the extruded polystyrene slabs on them. It is also possible to fix the fixtures in the slab first and then stick it to the waterproofing membrane.

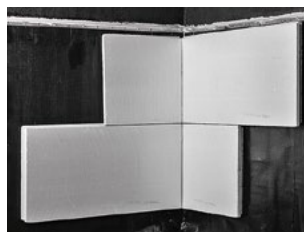

- Start installation of XPS slabs from the corners. In order to avoid formation of thermal bridges, install the slabs of adjacent rows with spacing of joints of half the slab size.

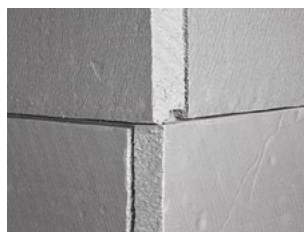

- Change the direction of XPS slabs connection in adjacent rows in corner area.

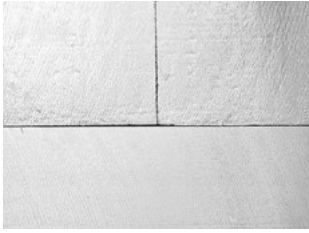

- Then continue with installation of entire slabs. The spacing of joints in adjacent rows will appear at the middle of the slab.

6.4. Backfill of the foundation pit



- Use the backfill soil according to the design.



- The backfilling is performed by layers with careful ramming of each layer up to the soil consistency values specified in the design.

NOTE: The sand layer thickness should be no more than 70 cm, clay sand and loam layer – 60 cm, clay layer – 50 cm.

7.

Quality control

7. Quality control

NOTE: During the quality control of installation of polymer-bitumen waterproofing membrane, first of all the membrane surface condition is visually checked for absence of cuts, burn-through, reinforcement exposure, swelling, bubbles and waves.



- The quality of all joints is controlled on all their length as well as rolls overlapping and spacing between end joints. The quality control of joints is performed for each layer in a multilayer membrane.



- The visual control is performed for the condition of the joint, its homogeneity and the band width of flowing out bitumen mass from the joint area, which should make **5±25 mm** (depending on material's thickness). There should be no residues of protective film at the roll edge in the joint area.



- The quality of the joint between rolls or pieces of polymer-bitumen membranes can be controlled by using a flat screwdriver with round edges (but not a cutting tool). The check is performed after complete cooling of the material.

In the places of poor-quality joints, the screwdriver passes between the layers of material forming the seam. Such places to be marked, and then the joints are restored by means of torch with small socket. If the good quality repair by means of torch with small socket is not possible, it is necessary to cover the damaged place with a patch, which should oversize the defect by at least **100 mm** in all directions.

When performing operations with polymer-bitumen materials, it is necessary to take precaution measures to prevent them from oils, petrol, diesel fuel and other solvents. In case of the waterproofing membrane damaging, the respective pieces are to be cut out and the patches are to be applied.

NOTE: A serious factor influencing the waterproofing membrane installation quality is the climatic (weather) situation. When working with polymer-bitumen materials, the ambient temperature and the temperature of the material must not be lower than the flexibility temperature of the material.

NOTE: Installation of the waterproofing membrane of polymer-bitumen materials by torching method is forbidden during a fog and in case of rime or hoarfrost on the surface of the building structure. In case of necessity to perform installation in unfavorable weather conditions, it is necessary to use special enclosures, canopies, sheds etc., ensuring the required conditions for installation.

8.

Safety precautions

8. Safety precautions

Installation of all layers of the waterproofing membrane must be performed with the use of individual protection equipment only.

The layers of the waterproofing membrane of polymer-bitumen materials are torched by hot method with bare flame use. A manual torch connected by means of an oxygen hose to a gas cylinder is required for the material installation. The oxygen hose is connected to the gas cylinder through a special transition device: the gas pressure reducer. Torching of materials must be performed with full observance of all safety requirements.

Upon completion of operations with the electric equipment, the portable power units are to be disconnected from energy sources and removed to a closed room.

The place of performing operations with the use of bare flame should have all necessary firefighting and first aid equipment, such as:

- Fire extinguishers;
- Sand boxes;
- Shovels;
- Asbestos cloth;
- First aid kits.

First medical aid in case of hot bitumen burns:

- Cool the bitumen with cold water until its full hardening and cooling;
- Do not remove the bitumen from the burnt place; it is necessary to consult a doctor as soon as possible.

TECHNONICOL India Private Limited

Head Office in Mumbai

102, Joy Villa, Plot No. 58,
Jawahar Nagar Road No. 4,
Goregaon (W),
Mumbai 400 104
Ph: +91 22 2872 8691
info@technicol.in

Office in New Delhi

Unit No. G-31, ground floor
TDI Centre,
Jasola District Centre,
New Delhi 110 025
Ph: +91 11 4372 1455
info@technicol.in

WWW.TECHNONICOL.IN